

---

# Solid-State Optical Mouse Sensor with PS/2 and Quadrature Outputs

## Technical Data

---

### HDNS-2000

---

#### Features

- **Optical Navigation Technology**
  - Superior precision and smooth navigation optimized for desktop and portable mouse applications
  - No moving parts, provides high reliability and needs no maintenance
- **Complete Compact 2-D Motion Sensor**
  - Easy implementation and design flexibility
  - Replaces mechanical ball system in traditional mice
- **Two Selectable Output Modes**
  - Standard 3-Button PS/2 Output Mode
  - Two Channel Quadrature Output Mode (X and Y Direction) which emulates encoder phototransistors
- **High Speed Motion Detection**
  - Accurately measures up to 12 inches per second at 400 cpi

- **Accurate Navigation over a Wide Range of Surfaces**
  - Enables mouse to be used with or without a mouse pad
- **Power Conservation Mode during No Motion**
- **Compatible with High Volume Manufacturing Processes**
  - Requires no precision optical alignment
  - Wave solderable

#### Applications

- **Computer Mice for Desktop PCs, Workstations and Portable Computers**
- **Integrated Input Devices**

#### Description

The HDNS-2000 is a low-cost reflective optical sensor that provides a non-mechanical tracking engine for implementing a computer mouse.

It is based on optical navigation technology which measures changes in position by optically acquiring sequential surface images (frames) and mathematically determining the direction

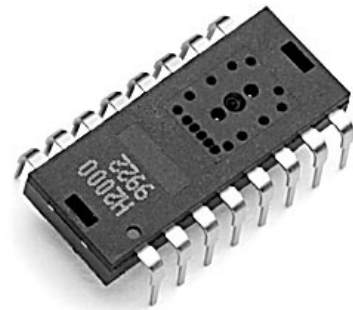

and magnitude of movement. The sensor is mounted in a plastic optical package and designed to be used with the HDNS-2100 (Lens), HDNS-2200 (LED Assembly Clip), and HLMP-ED800-xx000 (High Light Output 639 nm LED), providing a complete and compact tracking engine. This optical tracking engine has no moving parts and requires no precision optical alignment enabling high volume system assembly. The HDNS-2000 offers a PS/2 or quadrature output mode for interface flexibility. Resolution is specified as 400 cpi at rates of motion up to 12 inches per second.

*CAUTION: It is advised that normal static precautions be taken in handling and assembly of this component to prevent damage and/or degradation which may be induced by ESD.*

## Theory of Operation

The HDNS-2000 is based on Optical Navigation Technology. It contains an Image Acquisition System (IAS), Digital Signal Processor (DSP), and a mode selectable PS/2 or quadrature output converter. The IAS acquires images of microscopic

surface images via the lens and illumination system provided by the HDNS-2100, HDNS-2200 and the HLMP-ED800-xx000. These images are further processed by the DSP to determine direction and distance of motion. The DSP generates a stream of  $\Delta x$  and  $\Delta y$  relative displacement values

which are then communicated to the output converter. This converter provides a PS/2 3-Button output, replacing existing mouse microcontrollers, or two channel quadrature output, for direct interface to existing mouse microcontrollers.

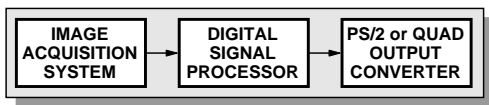

Figure 1. HDNS-2000 Block Diagram.

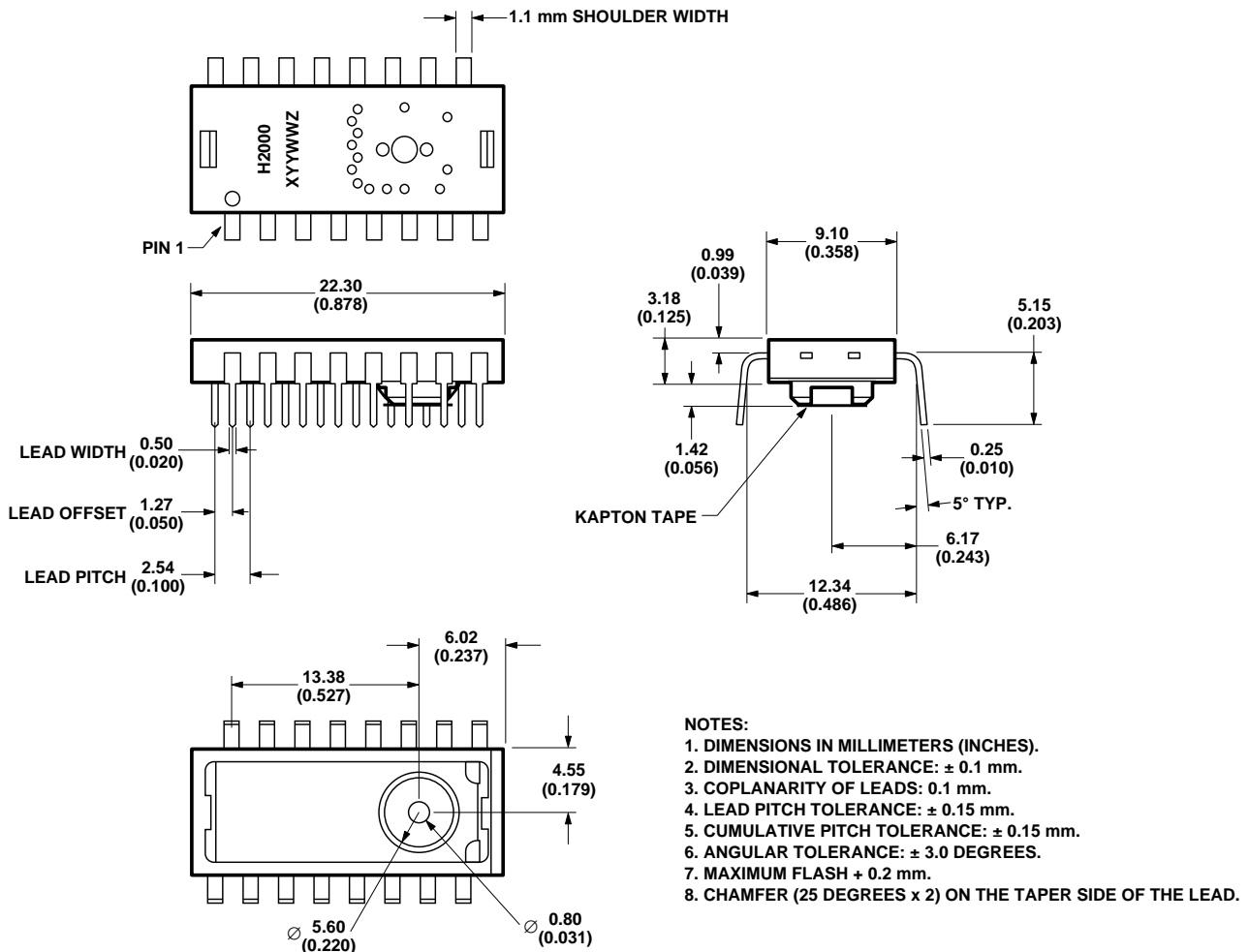

Figure 2. HDNS-2000 Sensor Package Outline Drawing.

## Pinout

Pin	Name	PS/2 mode	Quadrature mode
1	PS2_C	PS/2 Interface Clock	PS/2 Interface Clock
2	MODE/XA	Select PS/2 mode	XA output
3	RB/XB	Right Button input	XB output
4	MB/YB	Middle Button input	YB output
5	LB/YA	Left Button input	YA output
6	XY_LED	LED control output	LED control output
7	V <sub>DD3</sub>	3.3 VDC input	3.3 VDC input
8	REFB	Internal reference	Internal reference
9	OSC1	Oscillator input	Oscillator input
10	GND	Ground	Ground
11	OSC2	Oscillator output	Oscillator output
12	GND	Ground	Ground
13	V <sub>DD5</sub>	5 VDC input	5 VDC input
14	V <sub>DD5</sub>	5 VDC input	5 VDC input
15	NRESET	NRESET	NRESET
16	PS2_D	PS/2 Interface Data	PS/2 Interface Data

## 2D Assembly Drawing of HDNS-2000

Shown with HDNS-2100, HDNS-2200, and HLMP-ED800-xx000.

Agilent provides an IGES file drawing describing the base plate molding features for lens and PCB alignment. See HDNS-2100 Technical Data Sheet for more information.

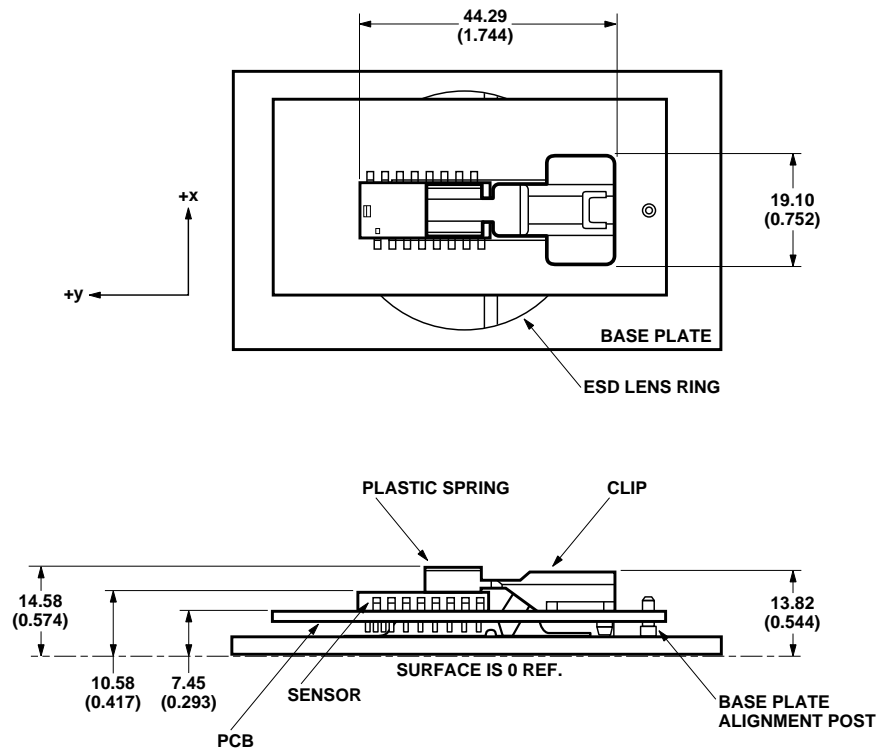

DIMENSIONS IN MILLIMETERS (INCHES)

Figure 3.

### Exploded View Drawing

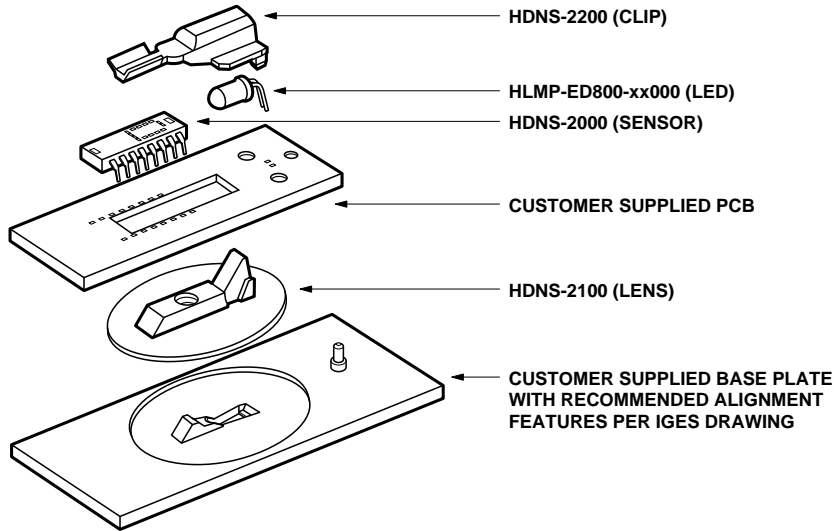
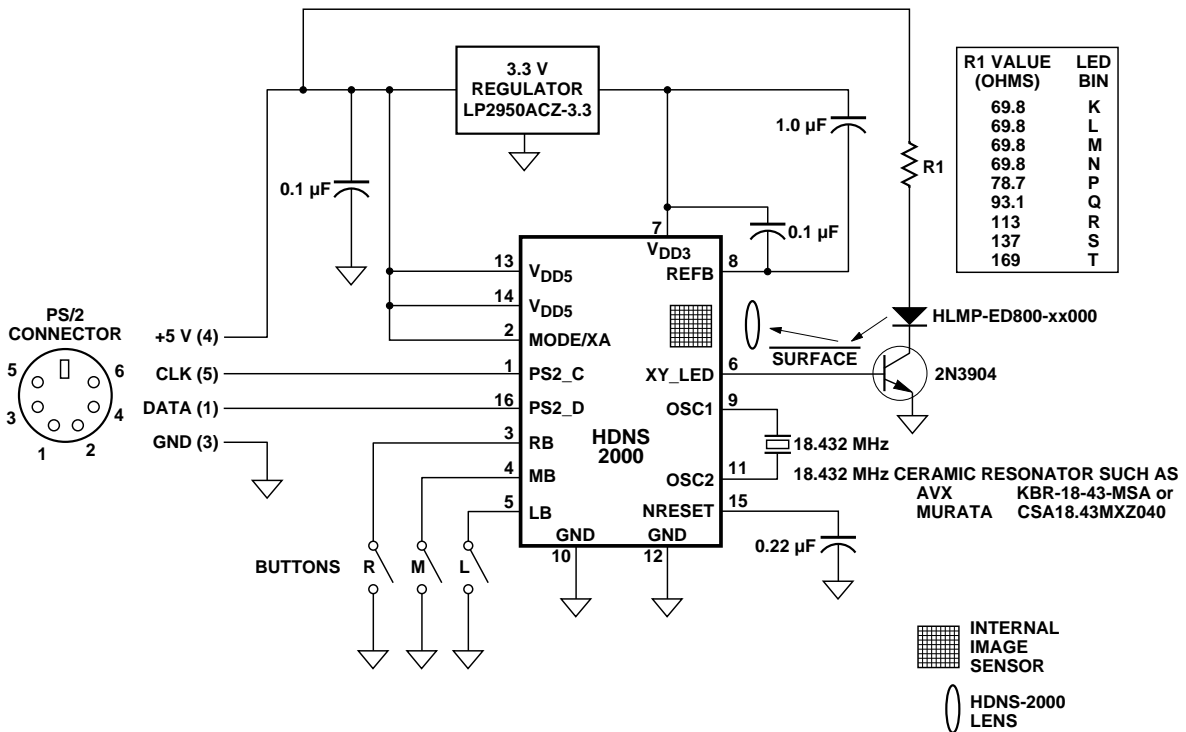

Figure 4.

### Typical Application using PS/2 Output



NOTE: 0.1 μF BETWEEN PINS 7 AND 8 MUST BE CERAMIC AND MUST BE TRACE LENGTHS LESS THAN 5 mm.

## Typical Application using Quadrature Output

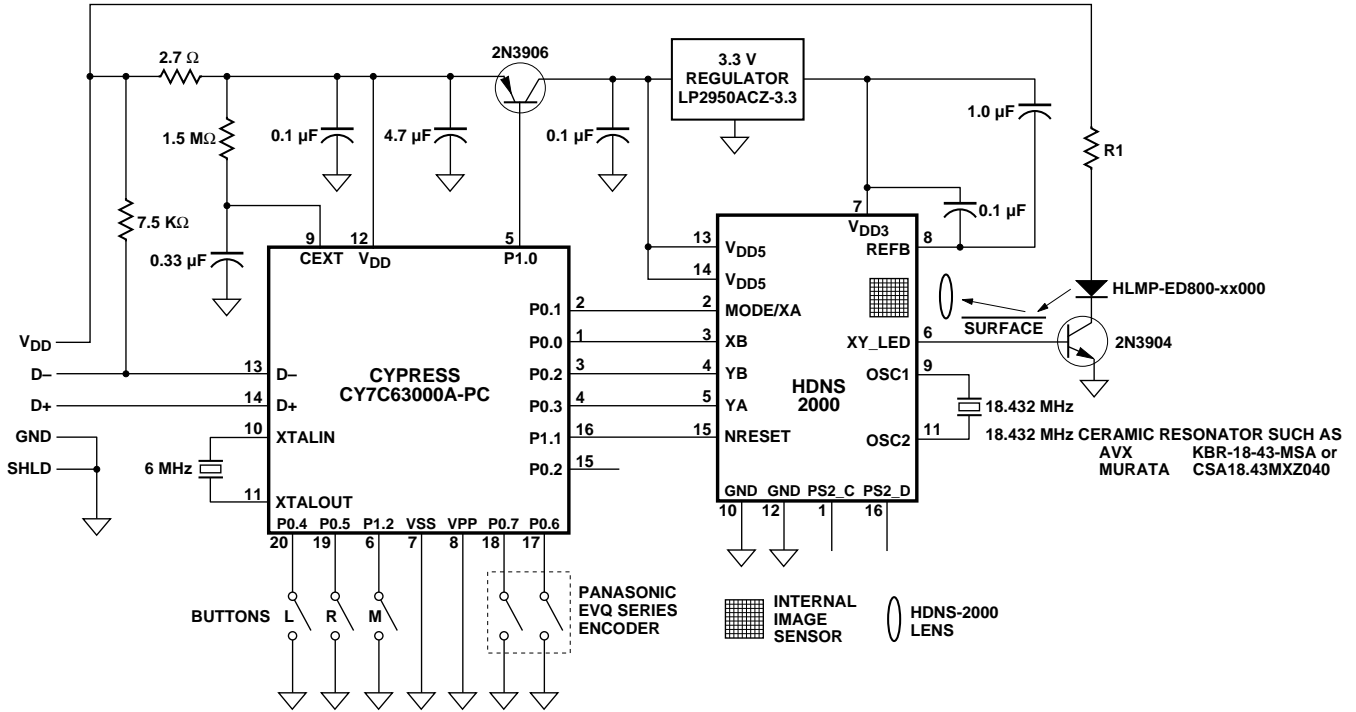

### NOTES:

- 1) DUE TO THE CYPRESS IMPLEMENTATION OF USB SUSPEND MODE SUPPORT, THE NRESET PIN OF THE HDNS-2000 MUST BE RESET USING A LINE FROM THE CYPRESS CHIP. THE REASON FOR THIS IS THAT THE CYPRESS CHIP DOES NOT CONFIGURE THE PORT INPUT PINS UNTIL AFTER IT HAS RECEIVED A BUS RESET FROM THE USB PORT. THE UNCONFIGURED INPUT PORT PINS PRESENT A 16 KΩ PULLUP TO V<sub>CC</sub>. IF A CAP IS USED ON NRESET (PIN 15), THIS PULLUP WILL RESULT IN THE HDNS-2000 SEEING A HIGH ON THE MODE PIN AND POWERING UP IN THE PS/2.
2. THE QUADRATURE INPUT PINS OF THE CYPRESS PART MUST BE PROGRAMMED TO BE HI-Z, INSTEAD OF THE NORMAL CURRENT PULLDOWNS. THIS ENSURES THAT THE HDNS-2000 WILL BE ABLE TO PULL THE QUADRATURE LINES HIGH OVER ALL CONDITIONS OF VOLTAGE AND TEMPERATURE.
3. 0.1 μF BETWEEN PINS 7 AND 8 MUST BE CERAMIC AND MUST BE TRACE LENGTHS LESS THAN 5 mm.

## Recommended LED Bin Table

LED Bin Category	R1 Value
K	69.8 Ω
L	69.8 Ω
M	69.8 Ω
N	69.8 Ω
P	69.8 Ω ~ 78.7 Ω
Q	69.8 Ω ~ 93.1 Ω
R	69.8 Ω ~ 113 Ω
S	69.8 Ω ~ 137 Ω
T	69.8 Ω ~ 169 Ω

**Note:** The 69.8 Ω resistor for bins K through N is determined by the absolute maximum rating of 50 mA for the HLMP-ED80. The other resistor values for other bins will guarantee good signals with reduced power.

## Absolute Maximum Ratings

Parameter	Symbol	Min.	Max.	Units	Notes
Storage Temperature	T <sub>S</sub>	-40	85	C	
Operating Temperature	T <sub>A</sub>	0	40	C	
Lead Solder Temperature			260	C	For 10 seconds, 1.6 mm below seating plane (see HLMP-ED800-xx000 data sheet for LED solder specifications)
Supply Voltage	V <sub>DD3</sub>	-0.5	3.6	V	
Supply Voltage	V <sub>DD5</sub>	-0.5	5.5	V	
ESD			2	kV	All pins, Human Body Model
Input Voltage	V <sub>IN</sub>	-0.5	V <sub>DD5</sub> +0.5	V	All I/O except OSC1 and OSC2
Input Voltage	V <sub>IN</sub>	-0.5	V <sub>DD3</sub> +0.5	V	OSC1 and OSC2

## Recommended Operating Conditions

Parameter	Symbol	Min.	Typ.	Max.	Units	Notes
Operating Temperature	T <sub>A</sub>	0		40	C	
Supply Voltage	V <sub>DD3</sub>	3.15	3.3	3.45	V	
Supply Voltage	V <sub>DD5</sub>	4.25	5.0	5.5	V	
Clock Frequency	CLK	17.4	18.432	18.7	MHz	Set by ceramic resonator
Resonator Impedance	X <sub>RES</sub>			40	Ω	
Reset Capacitor	C <sub>RESET</sub>	0.001	0.22	10.0	μF	
Distance from lens foot reference plane to surface	A	2.3	2.4	2.5	mm	Dimension A on HDNS-2100 data sheet
Speed	S	0		12	in/sec	
		0		30	cm/sec	
Acceleration	ACC	0		0.15	g	
Light level onto IC	IRR <sub>INC</sub>	40		25000	mWm <sup>2</sup>	λ = 639 nm

## DC Electrical Specifications

Electrical Characteristics over recommended operating conditions. Typical values at 25°C, V<sub>DD3</sub>=3.3, V<sub>DD5</sub>=5.0

Parameter	Symbol	Min.	Typ.	Max.	Units	Notes
Supply Current (mouse moving)	I <sub>DD3</sub>		9.3	15.5	mA	
Supply Current (mouse moving)	I <sub>DD5</sub>		4.7	9.5	mA	Pin 6=0.6 V
Supply Current (mouse not moving)	I <sub>DD5</sub>		1.9		mA	Pin 6=0.6 V
Input Low Voltage	V <sub>IL</sub>			0.8	V	
Input High Voltage	V <sub>IH</sub>	2			V	
Output Low Voltage (LED)	V <sub>OL</sub>		0.3	0.5	V	I <sub>OL</sub> =2 mA
Output Low Voltage (XA,XB,YA,YB)	V <sub>OL</sub>			0.5	V	I <sub>OL</sub> =4 mA
Output High Current (XA,XB,YA,YB)	I <sub>OH</sub>	100	300	600	μA	V <sub>OH</sub> =2.1 V
Output High Current (LED)	I <sub>OHBD</sub>	1.5	3.1	6	mA	V <sub>BE</sub> =0.6 V
Input Pull-up (RB,MB,LB)	I <sub>PU</sub>	100	300	600	μA	V <sub>IN</sub> =0.8 V
Output Low Voltage (PS/2)	V <sub>OL</sub>		0.41	0.5	V	V <sub>OL</sub> =20 mA
Output Pullup Current (PS/2)	I <sub>OH</sub>	300	625	1500	μA	V <sub>OH</sub> =2.0 V
Reset Pullup Current	I <sub>RESET</sub>	5	10	20	μA	V <sub>NRESET</sub> =2.0 V

## I/O Specifications

### PS/2 Command Set Implementation

The following commands are implemented. All other commands will cause an FE (resend) response from the HDNS-2000. A second invalid command will cause an FC (error) response from the HDNS-2000.

Mnemonic for Command	(HEX COMMAND) and Response Bytes	Mnemonics for Command and Response Bytes	Description	Valid Values and Default Value after Software or Hardware Reset
RESET	FF FA AA 00	FF ACK ID DT	Soft reset ID=AA DT=0	
RESEND	FE nn..	FE nn..	Resend last byte (i.e. ACK) or Packet	
SET_DFS	F6 FA	F6 ACK	Default Setting	
DISABLE	F5 FA	F5 ACK	Disable stream mode	{default mode}
ENABLE	F4 FA	F4 ACK	Enable stream mode	
SET_SAMPLING	F3 FA nn FA	F3 ACK nn ACK	Set sampling rate	{0A 14 28 3C 50 <b>64</b> C8} 10 20 40 60 80 <b>100</b> 200 reports/ second
READ_DT	F2 FA 00	F2 ACK DT	Responds with DT=00	
ECHO	EE FA	EE ACK	Echo all further commands until NO_ECHO or RESET	
NO_ECHO	EC FA	EC ACK	Respond to following commands normally	
READ_DATA	EB FA nn nn nn	EB ACK nn nn nn	Request a data packet	See IBM PS/2 Mouse Technical Reference
SET_STREAM	EA FA	EA ACK	Respond with data packets at the sample rate	{default mode}
SET_PROMPT	F0 FA	F0 ACK	Data only sent on READ_DATA	
STATUS	E9 FA nn nn nn	E9 ACK nn nn nn	Request status packet	See IBM PS/2 Mouse Technical Reference
SET_SCALE	E7 FA	E7 ACK	Pseudo Log	
LIN_SCALE	E6 FA	E6 ACK	Linear	{default mode}
SET_RES	E8 FA nn FA	E8 ACK nn ACK	Set resolution	{00 01 <b>02</b> 03} 2 4 <b>8</b> 16 Counts/mm
DISABLE_TEST	E8 FA AA FE	E8 ACK AA RESEND	For test purposes only	Default mode after hardware reset.

## PS/2 Mode Output Waveforms

### Host Sending Data Timing Diagram

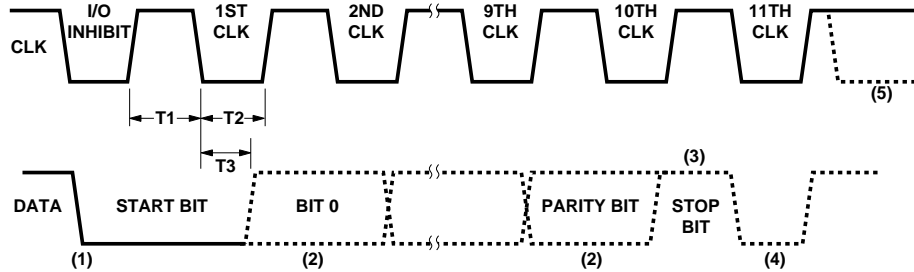

#### NOTES:

- 1) THE MOUSE CHECKS THE DATA LINE. IF THE LINE IS LOW, THE SYSTEM HAS DATA TO TRANSMIT. THE DATA LINE IS SET INACTIVE WHEN THE START BIT (ALWAYS 0) IS PLACED ON THE DATA LINE.
- 2) THE MOUSE SAMPLES THE DATA LINE FOR EACH BIT WHILE THE CLK LINE IS HIGH. DATA MUST BE STABLE WITHIN 1 MICROSECOND AFTER THE RISING EDGE OF THE CLK LINE.
- 3) THE MOUSE CHECKS FOR A HIGH STOP BIT AFTER THE 10TH CLK. IF THE DATA LINE IS LOW, THE MOUSE CONTINUES TO CLOCK UNTIL THE DATA LINE BECOMES HIGH, THEN CLOCKS THE LINE-CONTROL BIT, AND AT THE NEXT OPPORTUNITY SENDS A RESEND COMMAND TO THE SYSTEM.
- 4) THE MOUSE PULLS THE DATA LINE LOW, PRODUCING THE LINE-CONTROL BIT.
- 5) THE HOST CAN PULL THE CLK LINE LOW, INHIBITING THE MOUSE.

TIMING PARAMETER	DESCRIPTION	MIN. TIME	MAX. TIME
T1	DURATION OF CLK HIGH	30 $\mu$ SEC	50 $\mu$ SEC
T2	DURATION OF CLK LOW	30 $\mu$ SEC	50 $\mu$ SEC
T3	TIME FROM FALLING CLK TRANSITION, TO DATA TRANSITION	0 $\mu$ SEC	30 $\mu$ SEC

HOST SENDING DATA TIMING

### Host Receiving Data Timing Diagram

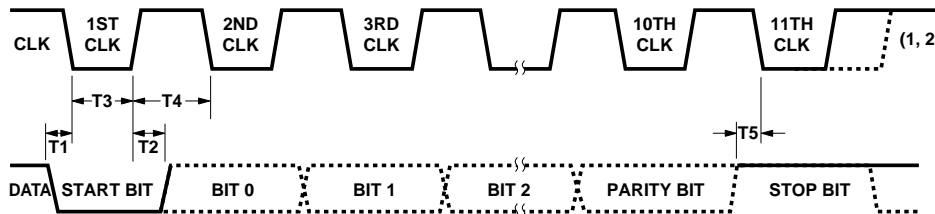

#### NOTES:

- 1) THE HOST CAN HOLD THE CLOCK SIGNAL LOW TO INHIBIT THE NEXT TRANSMISSION.
- 2) THE HOST RAISES THE CLOCK LINE TO ALLOW THE NEXT TRANSMISSION.
- 3) ALL TIMES GIVEN BELOW ASSUME AN 18.432 MHz RESONATOR AND ARE DEPENDENT UPON ITS ACCURACY.

TIMING PARAMETER	DESCRIPTION	MIN. TIME	MAX. TIME
T1	TIME FROM DATA TRANSITION TO FALLING EDGE OF CLK	5 $\mu$ SEC	25 $\mu$ SEC
T2	TIME FROM RISING EDGE OF CLK TO DATA TRANSITION	5 $\mu$ SEC	25 $\mu$ SEC
T3	DURATION OF CLK LOW	30 $\mu$ SEC	50 $\mu$ SEC
T4	DURATION OF CLK HIGH	30 $\mu$ SEC	50 $\mu$ SEC
T5	TIME TO MOUSE INHIBIT AFTER CLOCK 11 TO ENSURE THE MOUSE DOES NOT START ANOTHER TRANSMISSION	0 $\mu$ SEC	50 $\mu$ SEC

HOST RECEIVING DATA TIMING



## Quadrature Output Mode Waveform

The 2 channel quadrature outputs are 5 V CMOS outputs. The Delta X count is used to generate the XA and XB quadrature signals. The Delta Y count is used to generate the YA and YB quadrature signals. Delta X,Y counts are in the range of +7 to -7 counts of motion and new Delta X,Y values are generated at a rate of 1500 Hz. The quadrature signals can change at a maximum rate of 12.5 kHz.

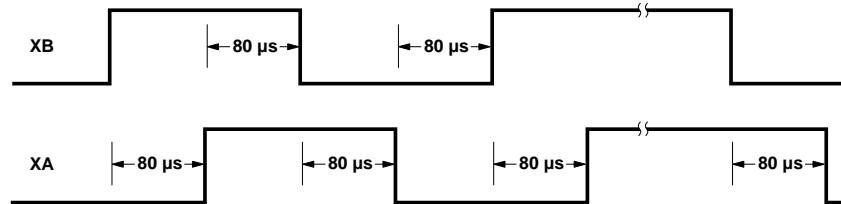

EXAMPLE QUADRATURE OUTPUT WAVEFORM (+X MOTION)

## AC Electrical Specifications

Electrical characteristics over recommended operating conditions. Typical values at 25°C,  $V_{DD3}=3.3$ ,  $V_{DD5}=5.0$ ,  $A=2.4$  mm,  $CLK=18.432$  MHz

Parameter	Symbol	Min.	Typ.	Max.	Units	Notes
PS/2 baud rate	Fps2	10	12.5	15	Kbaud	
PS/2 data transition delay after PS/2_C rising edge	T2	10	20	25	$\mu$ s	See PS/2 Timing Diagrams
PS/2 motion report rates			100		reports/sec	See PS/2 command settings
Motion scale factor			400		counts/inch	
Power up delay				100	ms	$C_{RESET}=0.22 \mu$ F

## Typical Performance Characteristics

Typical Performance of HDNS-2000 assembled as shown in Figure 3 with HDNS-2100 Lens, HNDS-2200 LED Assembly Clip, and HLMP-ED800-xx000.

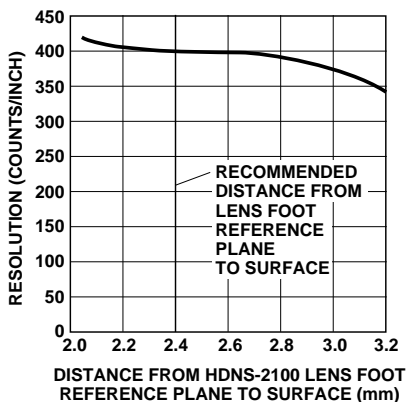

Figure 5. Typical Resolution vs. Assembly Height.

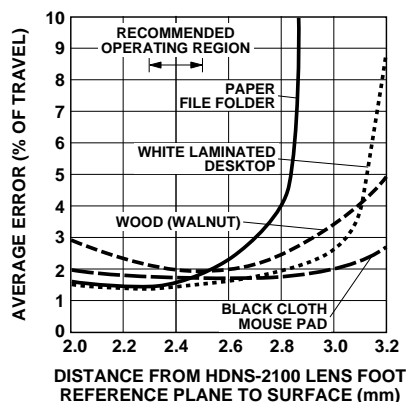

Figure 6. Typical Error vs. Assembly Height.

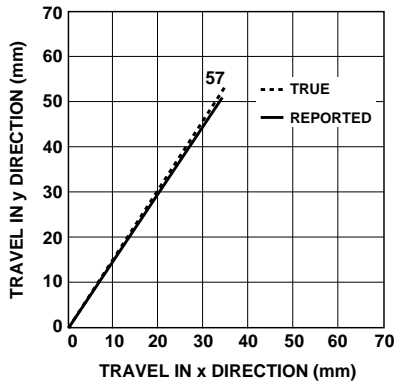

Figure 7. Typical Reported Path vs. True Path.

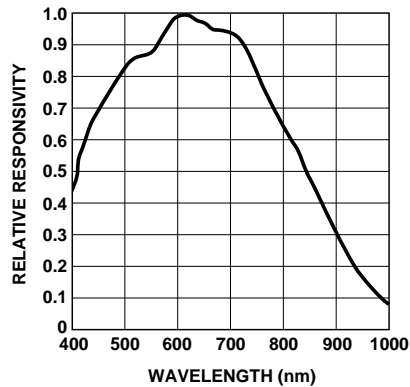

Figure 8. Typical Responsivity vs. Wavelength.

## Ordering Information

Specify Part Number as follows:

- HDNS-2000 = Sensor IC in a 16-pin plastic optical package,  
20 per tube, 1000 pcs in a box.
- HDNS-2100 = Optical mouse round lens.
- HDNS-2100-001 = Optical mouse trimmed lens.
- HDNS-2200 = LED assembly clip (back).
- HDNS-2200-001 = LED clip (clear).
- HDNK-2000 = Solid-state optical mouse sample kit.
- ADNB-2010 = HDNS-2000 sensor and HDNS-2100 round lens  
bundle kit, 1000 pcs incremental.
- ADNB-2011 = HDNS-2000 sensor and HDNS-2100-001 trimmed  
lens bundle kit, 1000 pcs incremental.
- HLMP-ED800-xx000 = LED.

**[www.agilent.com/semiconductors](http://www.agilent.com/semiconductors)**

For product information and a complete list of distributors, please go to our web site.

For technical assistance call:

Americas/Canada: +1 (800) 235-0312 or  
(916) 788-6763

Europe: +49 (0) 6441 92460

China: 10800 650 0017

Hong Kong: (+65) 6756 2394

India, Australia, New Zealand: (+65) 6755 1939

Japan: (+81 3) 3335-8152 (Domestic/International), or 0120-61-1280 (Domestic Only)

Korea: (+65) 6755 1989

Singapore, Malaysia, Vietnam, Thailand,  
Philippines, Indonesia: (+65) 6755 2044

Taiwan: (+65) 6755 1843

Data subject to change.

Copyright © 2004 Agilent Technologies, Inc.  
Obsoletes 5988-4073EN

May 12, 2004  
5988-9329EN